

INTELLIGENT
EFFICIENT
FEEDING

DEPRAG



STEP FEEDER SYSTEM

For the best in efficiency, intelligence and technical cleanliness – the new DEPRAG step feeder system: eacy step feed

Specially designed for longer screws!

The complete system, comprising a storage container, material-handling technology, linear conveyor, separator, housing and controller – specially designed for longer screws – offers hassle-free, reliable operation with 24V technology, independent from mains voltage and mains frequency.

The DEPRAG step feeder system combines all the advantages of a step feeder with the outstanding energy-efficiency of DEPRAG's vibration and regulating technology.

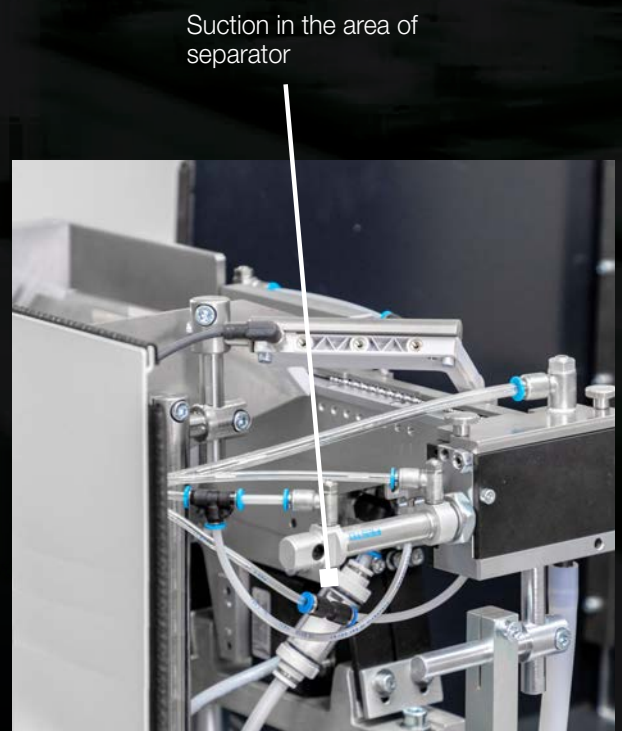



Any particles generated in the feeding area are caught and expelled



Advantages

The feeding system eacy step feed exhibits particularly gentle handling of feed material. Vibration is only used in the vicinity of the linear feed rails.

A brushless electric motor, controlled by the smart energy-efficient PFC100 controller, is used to drive the feed plates. The controller also regulates conveyor speed, supporting the gentle feeding of parts.

This gentle part handling and low-friction feeding guarantees that particle build-up is kept to an absolute minimum. However, there is also the option of adding vacuum suction equipment to boost technical cleanliness at certain interface points. The DEPRAG CleanFeed concept is also available for each processing step of the eacy step feed system – from component handling and feeding to fastening – prevent, reduce and remove abrasion.

The step feeder can also be optionally combined with DEPRAG storage systems. They are the ideal complement for optimal processing, ensuring a constant fill volume and extended re-load intervals. Eacy step feed is, of course, also compatible with DEPRAG's other automation components, such as the DEPRAG Feed Module DFM, the DEPRAG Screwdriver Function Modules and DCOS, the DEPRAG Controller System.

The high feed rate, long life-span and compact size – specifically for longer feed parts – provides an alternative to vibratory spiral feeders and sword feeders.

Outstanding reliability and efficiency

- **Automatic feeding and alignment**
 - even complex components are correctly oriented
- **Drive via brushless electric motor**
 - gentle feeding of parts
 - direct conveyor speed control
- **Quiet, gentle, low friction feeding**
- **Technical cleanliness**
- **High feed rate**
- **Compact size**
- **Long life-span**
- **Low maintenance and wear**
- **Reliable and hassle-free**
- **Modular design**
 - compatible with DEPRAG's other automation components
- **On-site service**
 - fast response at service or maintenance

Main features of the step feeder



The feed material is quietly fed in stages over linear feed plates from the storage container towards the feed rails.

A brushless electric motor, controlled by the smart energy-efficient PFC100 controller, is used to drive the feed plates.

The controller also regulates conveyor speed, supporting the gentle feeding of parts.

The integrated sequence controller PFC100 regulates the complete feeding process for -EP and 12911-x designs used in combination with handheld screwdrivers. Each new cycle is triggered via a start impulse.

This significantly reduces integration in higher-level system controllers. As an alternative, the system can also be controlled via an external PLC/IPC controller.

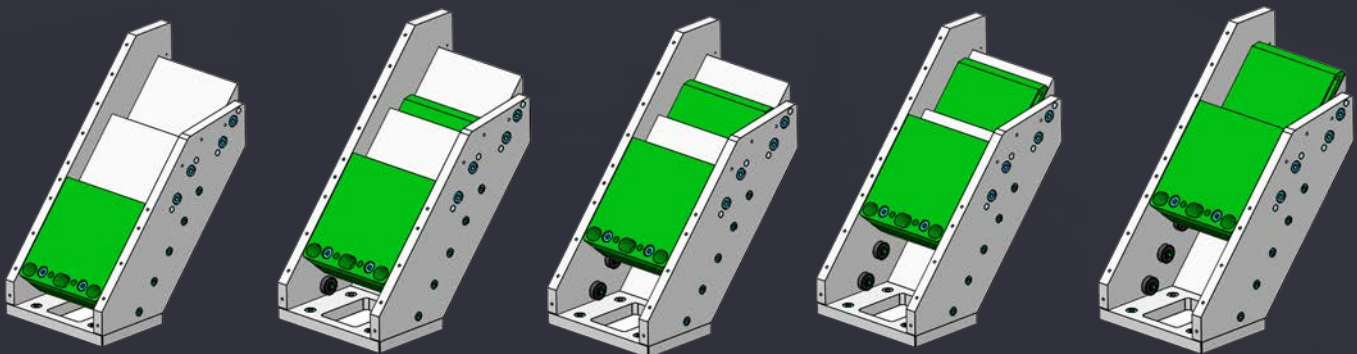

The feed material is geometrically aligned in the feed rails.

A linear conveyor then transports the feed parts towards the separator.

Fill level sensors in the storage container and the feed rails measure and regulate the feed rate.

In the separator the feed material is separated and pre-positioned to be shot through the feed hose or for pick-up using vacuum tool or gripper.

However, there is also the option of adding vacuum suction equipment to boost technical cleanliness at certain interface points.

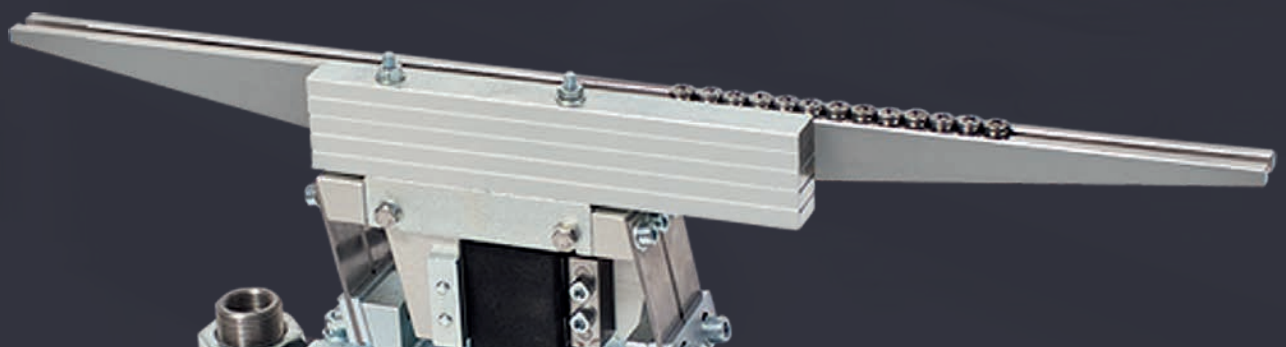

In combination with DEPRAG storage systems – optimize processing by maintaining a constant fill level – no need to adjust the feed rate

DEPRAG storage systems are an ideal complement to your feed system for a significant increase in refill intervals.

Flexible

No need for costly modifications when using a variety of feeders. The hopper outlet is adjustable to the size of the component. Additional regulating options allow the hopper to be adjusted into two different directions.

Low noise and wear-resistant

The outflow-chute is enclosed, resulting into a substantial reduction in noise.

Noise-barriers are available as a special accessory for all vibratory feeders; they are specifically designed for use together with a hopper.

Simple operation and easy set-up

The DEPRAG hoppers come with a 24-volt gear motor. They can be operated simply via an output on the higher-level PLC.

Gentle component handling

Gentle component handling minimizes the waiting time of feed parts in the vibratory system.

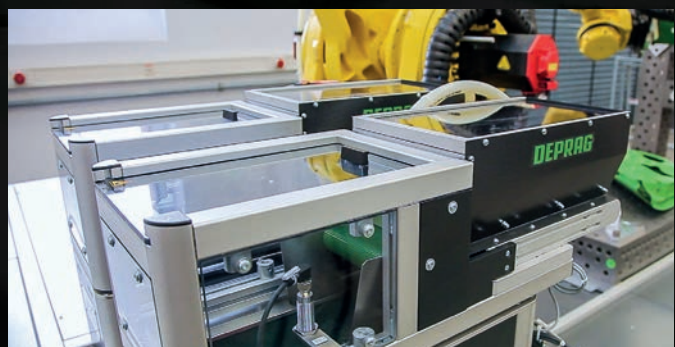

Upgrade features for TECHNICAL CLEANLINESS for clean room applications

The DEPRAG CleanFeed concept for each processing step – from component handling and feeding to fastening – prevent, reduce and remove abrasion.

The CleanFeed concept – a universal solution!

Avoid abrasion

The aim is to avoid the creation of particle deposits when feeding the fastener and during the actual screwdriving process.

Reduce abrasion

If the screw is fed directly to the assembly, particle contamination cannot be ruled out. We developed the DEPRAG Particle Killer for issues such as these. This system cleans the blast-air used for feeding the screw and additionally removes left-over particles at the end-tooling where the screw is retained before actual screwdriving. Furthermore, we also offer screwdriver function modules [SFM] for underfloor [inverted] screw assembly, where gravity alone keeps dirt particles from getting to the screw location.

Remove abrasion

Dirt particles are targeted and removed via vacuum suction. The cleaned fastener is then fed into the screwdriving module or is ready for pick-up from a pick & place device.



Compatible with DEPRAG automation components



DFM – DEPRAG FEED MODULE

Advantages:

- Ergonomic
- Process reliable
- Efficient
- Flexible
- Maintenance friendly
- Various designs
- Suitable for lightweight robots
- Complete solution from a single source

The DEPRAG Feed Module enables fatigue-free processing due to the integrated bit stroke.



Ergonomic

Uncomplicated handling and fatigue-free processing due to the integrated bit stroke

Process reliable

- constant pressure force as a result of the integrated bit stroke
- automatic documentation of processing data

Efficient

- Optimised cycle time
- automatic feeding of fasteners
 - fast positioning of the screw due to the integrated lock stroke
- No PLC required
- integrated sequence controller via the feeding system



Flexible

- can be combined with electronic or pneumatic drives
- all screwdriving parameters are freely adjustable
- suitable for both stationary and manual applications

Maintenance friendly

Tool-free quick-change system for bit and positioning sleeves

Various designs

Straight design with handgrip, pistol grip design, version without handgrip for robotic applications, vacuum design for difficult-to-reach screw positions

Suitable for lightweight robots

The low weight of the DEPRAG Feed Module makes it ideal for applications which use lightweight robots.

Complete solution from a single source

The DEPRAG Feed Module can be used in combination with all DEPRAG feeding systems and handling devices.

Further information and technical details can be found in our catalog D3837E.



Compatible with DEPRAG automation components

SFM – DEPRAG Screwdriver Function Module

Advantages:

- wide product variety for all applications
- maximum ease of integration
- service optimized
- suitable for a complete process documentation
- standard modules allow for short delivery times

Screwdriver Function Modules are the basis of any automated, process-reliable screw-assembly.

You benefit from our long-standing experience in the fields of screwdriving technology and assembly automation.

We offer both single-spindle and multi-spindle units with electric or pneumatic drive.

Further information and technical details can be found in our catalogs:

D3310E Screwdriver Function Module for an automated production

D0062E Screwdriver Function Module with electronic stroke

D0064E Screwdriver Function Module with magazine

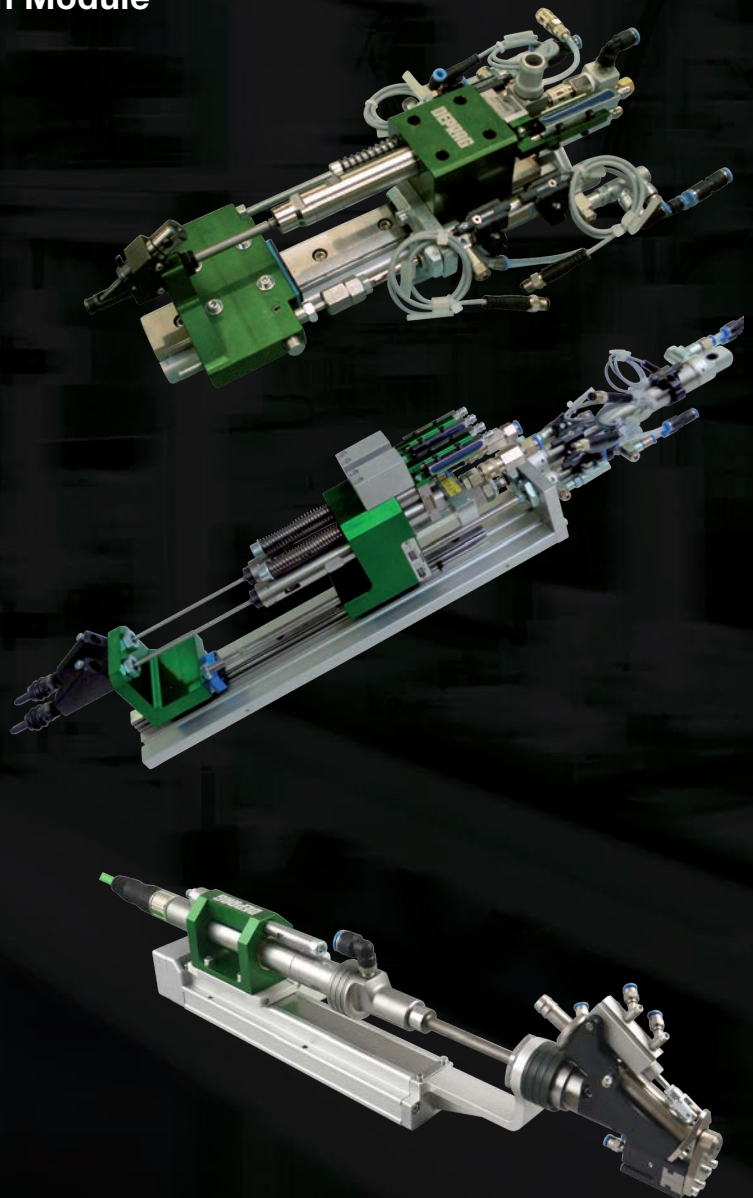

Compatible with DEPRAG automation components

DCOS – DEPRAG CONTROLLER SYSTEM

Advantages:

- integrated standard software guarantees the highest functionality
- simple and reliable operation
- service friendly remote maintenance
- great value for money – optimal adaptation to DEPRAG screwdriving technology
- open connectivity and integrated network capabilities
- conforms to current safety standards
- realtime data integration

The DCOS (DEPRAG CONTROLLER SYSTEM) is designed to fulfil the highest requirements. It is particularly user friendly and has high functionality. The DCOS controls, records, documents and analyses.

The integrated networkability enables unproblematic connection to SCADA and MES systems, optimal data administration and storage and above all, the access to common PC applications such as browsers, data back-up and remote access opens up almost infinite user possibilities.

A DCOS consists of:

- the control and operating unit DPU
- the control cabinet DSEC
- and standardized software packages

Further information and technical details can be found in our catalog D3350E.

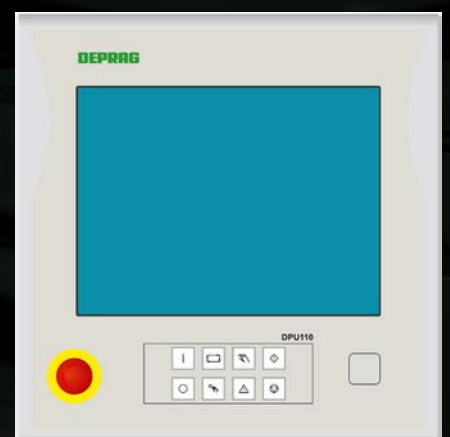
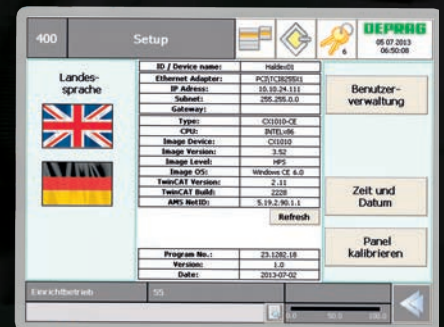

Technical data

hand guided application

Material conveyed	screws, threaded pins,
	
Standard version type	12911-2.0
Integrated controller	PFC100 Controller (with modified software)
Transport principle	step feeder
Amount of connectable drivers	1
Feed rate approx. Parts/min	30
Filling capacity liter/gal.	2.0/0.53
Voltage V/Hz	24 Volt DC
Power consumption VA	max. 150
Air pressure requirement bar/PSI	6/85.2
Air connection size mm/in.	10 ² / ₈
Dimensions (WxDxH) mm/in.	488.5 x 430 x 1024 / 19.05 x 16.77 x 39.94
Weight kg/lbs	approx. 72/158.4
Feedhose length standard m/ft.	2/6.56
Feedhose length max. m/ft.	8/26.4
Technical details on material conveyed:	
Max. head diameter mm/in.	16/0.62
Max. shaft length mm/in.	60/2.34
Range of shaft diameter mm/in.	3 - 8 / 0.12 - 0.31
Included in delivery:	Power unit 2041061, retaining plate (holder for power unit) 1126962, feeder stand 133118A
Required accessories:	Power cable 812587 (EU), 812295 (US), 833792 (UK), 832927 (CN), 207388 (BR), mouthpiece guide, mouthpiece, nosepiece split type or nosepiece ball type
Optional accessories:	Base for feeder stand 999309 Fill level indicator 414470D (in the container, inductive from below) Hopper (see brochure D3850E) Set of wheels for stand (also in ESD-capable version) Special mouthpiece for critical screw head diameter to length relation Part template for positioning

 Our software solutions undergo continuous improvements. We recommend that you regularly update your software. In this way you will always receive the most up-to-date security updates, upgraded features and drivers. With the most current version of the software you can be sure that your device is optimally prepared for Industry 4.0.

 A connecting cable is required to connect external controller with feeder. Part number will be assigned in case of an order. Every feeding system contains all required attachments for the screwdriver such as mouthpiece guide, mouthpiece, locking sleeve and bits. Various specialized versions are available depending on application and the screwdriver in use.

Dimensions

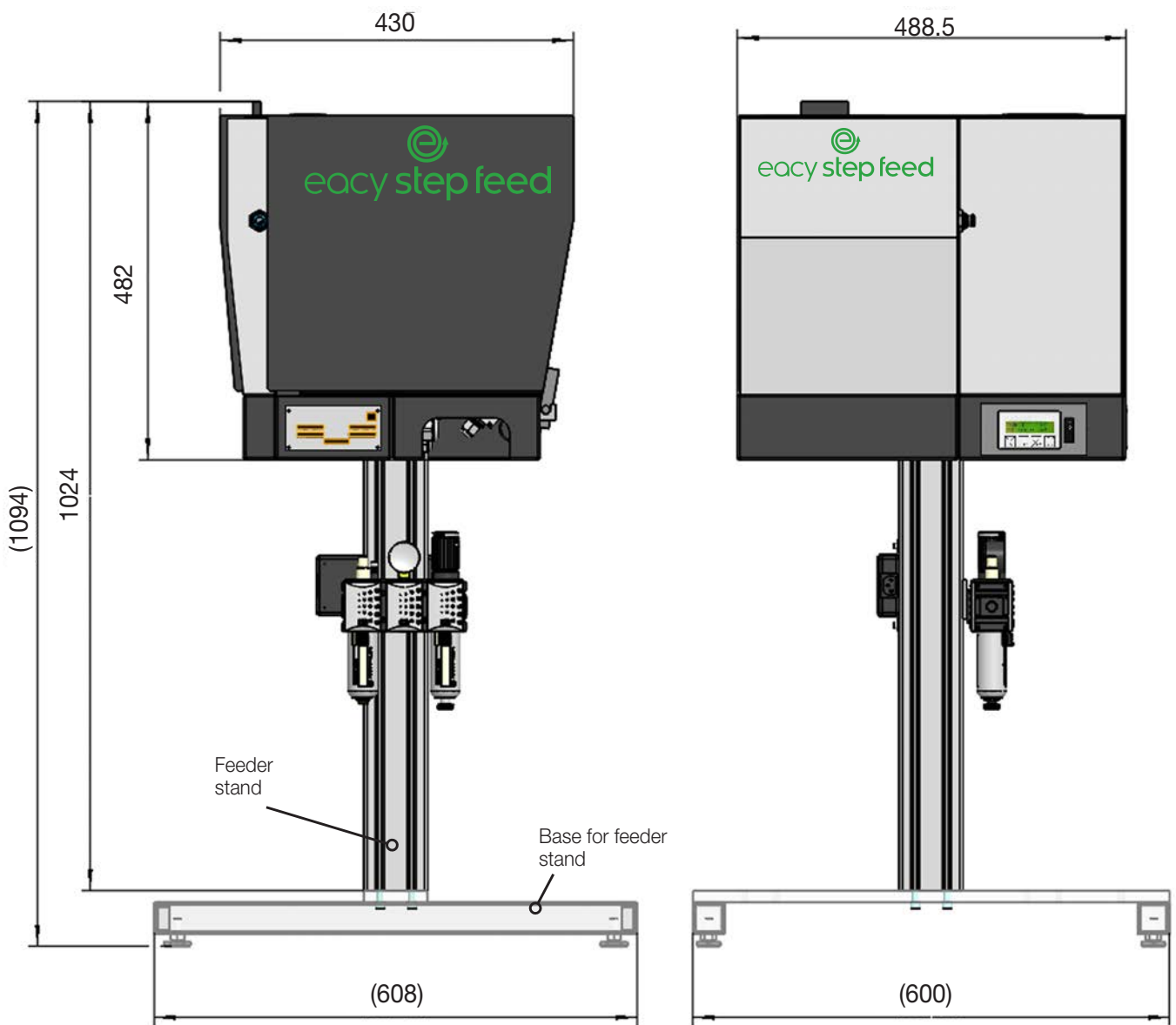

12911-2.0

Technical data

stationary application

Material conveyed	Screws, threaded pins,								
									
Filling capacity 2.0 l/0.53 gal. with PLC	Type	02911-EP/2.0	-	-	-	-	-	-	
Filling capacity 2.0 l/0.53 gal. without PLC	Type		02911 -0/2.0 -P/2.0 -0/2.0V -P/2.0V	02911 -2-0/2.0 -2-P/2.0 -2-0/2.0V -2-P/2.0V	02911 -3-0/2.0 -3-P/2.0 -3-0/2.0V -3-P/2.0V	02911 -4-0/2.0 -4-P/2.0 -4-0/2.0V -4-P/2.0V	02911 -5-0/2.0 -5-P/2.0 -5-0/2.0V -5-P/2.0V	02911 -6-0/2.0 -6-P/2.0 -6-0/2.0V -6-P/2.0V	
Control unit		PFC100 controller (insulation IP54)							
Amount of connectable drivers		1	1	2	3	4	5	6	
Feed rate max.	Parts/min	30	30	2x15	3x10	4x8	5x6	6x5	
Filling capacity	l/gal.	2.0/0.53	2.0/0.53	2.0/0.53	2.0/0.53	2.0/0.53	2.0/0.53	2.0/0.53	
Max. head diameter	mm/in.	16/0.62	16/0.62	16/0.62	16/0.62	16/0.62	16/0.62	16/0.62	
Max. shaft length	mm/in.	60/2.34	60/2.34	60/2.34	60/2.34	60/2.34	60/2.34	60/2.34	
Range of shaft diameter	mm/in.	3/0.12-8/0.31	3/0.12-8/0.31	3/0.12-8/0.31	3/0.12-8/0.31	3/0.12-8/0.31	3/0.12-8/0.31	3/0.12-8/0.31	
Voltage	V	24 Volt DC							
Max. power consumption	VA	150							
Air pressure requirement	bar/PSI	6/85.2							
Air hose diameter	mm/in.	10 ³ / ₈							
Weight approx.	kg/lbs.	70/154	73/160.6	76/167.2	78/171.6	78/171.6	80/176	80/176	
Dimensions (WxDxH) approx.	mm/in.	488.5 x 430 x 1024 / 19.05 x 16.77 x 39.94							
Feed hose length - standard	m/ft.	4/ ⁵ / ₃₂	4/ ⁵ / ₃₂	4/ ⁵ / ₃₂	4/ ⁵ / ₃₂	4/ ⁵ / ₃₂	4/ ⁵ / ₃₂	4/ ⁵ / ₃₂	
max.	m/ft.	8/ ⁵ / ₁₆	8/ ⁵ / ₁₆	8/ ⁵ / ₁₆	8/ ⁵ / ₁₆	8/ ⁵ / ₁₆	8/ ⁵ / ₁₆	8/ ⁵ / ₁₆	
Number of in-/outputs needed for PLC version „0“ and „P“		3/1	6/6	9/8	11/10	13/10	15/12	16/12	
Additional version „V“		-	7/7	11/10	14/13	17/14	20/17	22/18	
Included in delivery:		Power unit 2041061, retaining plate (holder for power unit) 1126962, feeder stand 133118A							
Required accessories:		Power cable 812587 (EU), 812295 (US), 833792 (UK), 832927 (CN), 207388 (BR)							
Optional accessories:		Ring proximity switch with impulse extension 100 ms, with connector, cable and connector plug for screw presence control installed an							
		Base for feeder stand 999309							
		Fill level indicator 414470D (in the container, inductive from below)							
		Hopper (see brochure D3850E)							
		Set of wheels for stand (also in ESD-capable version)							



Our software solutions undergo continuous improvements. We recommend that you regularly update your software. In this way you will always receive the most up-to-date security updates, upgraded features and drivers. With the most current version of the software you can be sure that your device is optimally prepared for Industry 4.0.

Dimensions

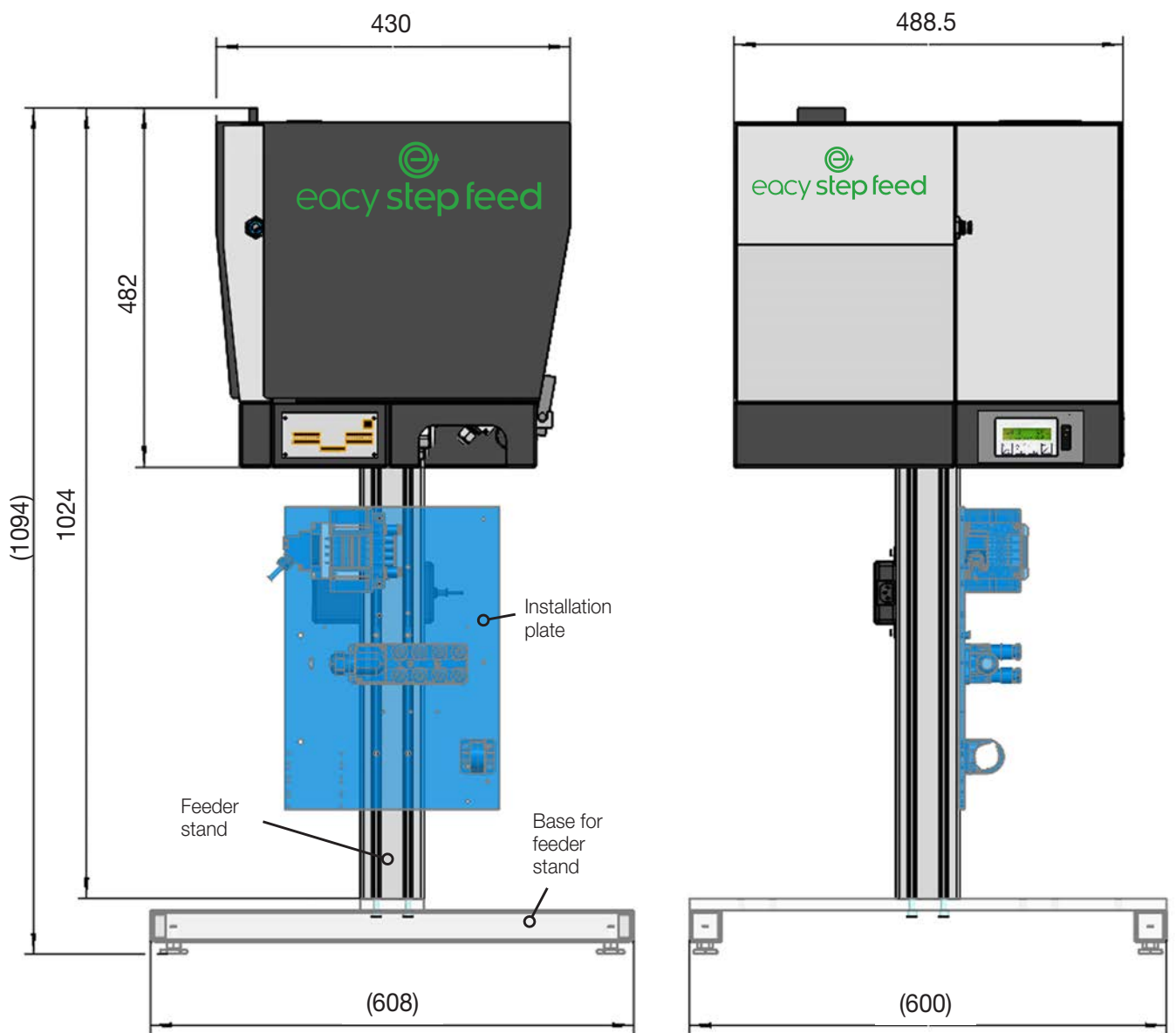

02911-x-x/2.0(V)

Nomenclature of feeders

i. e. 0 29 1 1 - 3 - P / 2.0 V

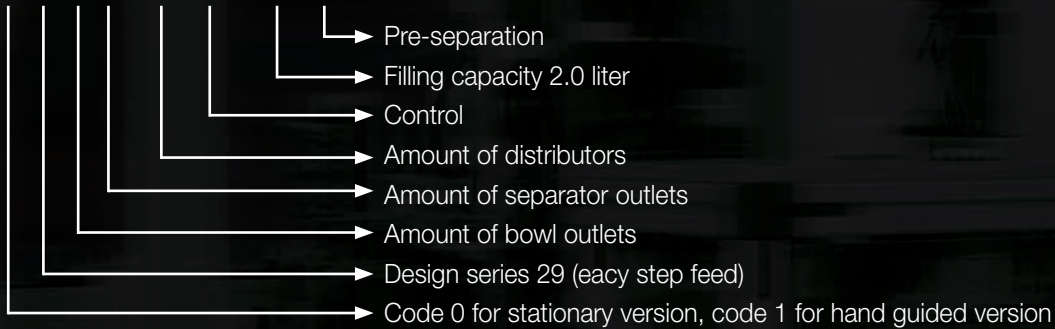

Software solutions

PFC100 Manager – the parameterization software for PFC100 controllers

The PFC100 Manager facilitates the reading and saving of parameters as text files for every PFC100 controller. Saved parameters can be transferred to any PFC100 controller quickly and simply using the PFC100 Manager.

The connection cable 385520B required to connect the PC and PFC100 must be ordered separately.

The software download is available from the myDEPRAG customer portal (my.deprag.com). Registered users can activate the activation code and manage licences in MY ACCOUNT > DEPRAG Apps.

Available languages: German and English

Part number:

Activation key for the software – part no. 122000

Further information can be found in our catalog D3900E or on our website www.deprag.com.



DEPRAG
machines unlimited

**Your global partner for
screwdriving technology, feeding
technology and automation**



More information:
www.deprag.com