

TECHNICAL INFORMATION

SCREWDRIVING TECHNOLOGY AND QUALITY ASSURANCE



Overview

This special edition is a way to convey our expertise in regards to theoretical basics and to simultaneously offer a practical application guide.

Introduction	Page 2
Basics of the Screwdriving Technology	Page 3
Tightening Process	Page 6
Selection of a Suitable Screwdriving System / Application Advice	Page 9
Process Reliability	Page 9
Statistics	Page 11
Accuracy in the Screwdriving Technology	Page 14
Measuring Principles	Page 15
Calibration of Measuring Instruments	Page 17
Standards / Guidelines / Literature	Page 18

Introduction

Screwdriving technology continues to be a key field of technology for many varied assembly tasks. Screw connections are desirable due to their resilience, reusability of components and the option of disassembling the connection at any time without destroying the parts. Screws are the most frequently used machining elements which are both standardised and available in such a wide range of designs.

In screw assembly there are various targets such as:

- Generation of a defined preload force
- Screw assembly to depth (adjustment procedure)
- Assembly to defined angle
- Pre-drilled thread / thread cutting or forming
- Clearance test of screws, threaded pins and nuts with tolerance values
- Friction calculation
- Checks whether sealant or microencapsulated adhesive is present on the screw
- Releasing screw connection

The increasing complexity of tasks and rising requirements for technological process reliability to top quality standards necessitates a comprehensive specialist knowledge in the design and operation of optimised screwdriving and assembly systems.

Basics of the Screwdriving Technology

Aim of the screwdriving process is either to apply a defined holding force (preload force) or the realisation of certain adjustment or disassembly procedures.

Application of a defined preload force

The most important application case is the determination of a defined preload force. The preload force has to be determined in such a way, that on one hand the intended function is still given and on the other hand, the allowable load of the screw-connection is not exceeded. The most common problems are settling conditions of a joint and other assembly related fluctuations of the achieved preload force. Series screw assembly does not allow effective determination of the required preload force. Therefore as an alternative, indirect measurements must be used to control the assembly process. Generally it is the tightening torque of the screw assembly. The required tightening torque can be calculated from the preload force using the VDI 2230 formula.

Additionally other parameters such as angle, screw-in time, friction etc. can be experimentally determined which serve as guide dimensions for the assembly process.

Furthermore, innovative procedures have been developed for the detection of the head seating point in order to improve the constancy of the preload force.

Reference values are provided by tables, as shown on pages 4 and 5.

Basically by using the length measurement an additional indirect measurement value can be used to determine the preload force. These processes are however very complicated and therefore not of great use in practice. Using the torque to determine measurement dimensions is still the best option due to its practical feasibility.

Realisation of realignment and disassembly procedures

In these cases the described processing dimensions are either a length measurement (screw-in or screw-out depth) or an angle measurement (number of rotations). These dimensions can be recorded directly via a suitable measurement system or indirectly over time.

One example is the assembly of terminal connectors:

The clamping screw is firstly tightened to a predefined torque and then unscrewed to a certain angle in order to enable easier connection of a wire.

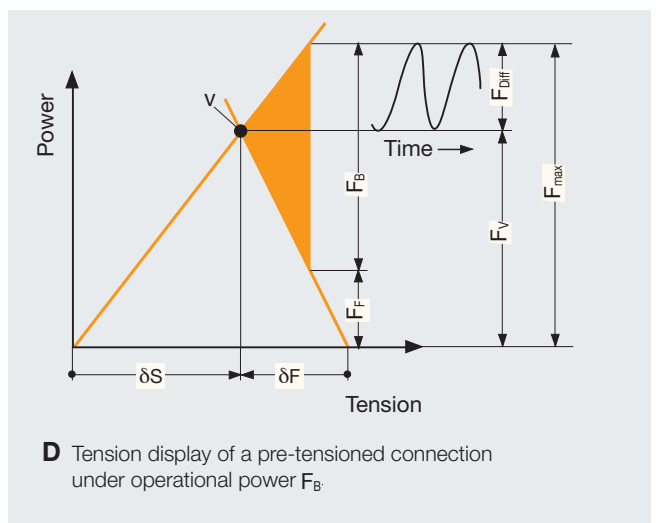
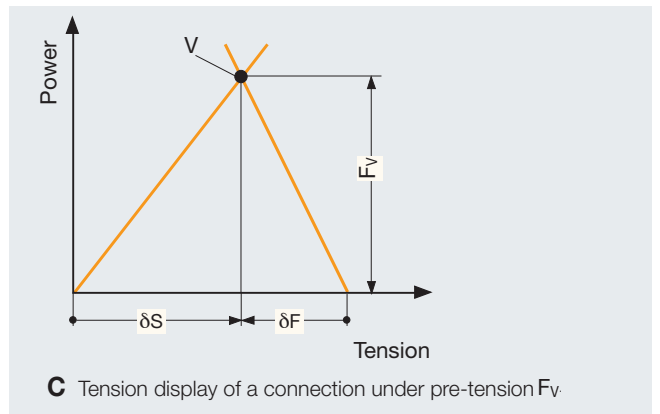
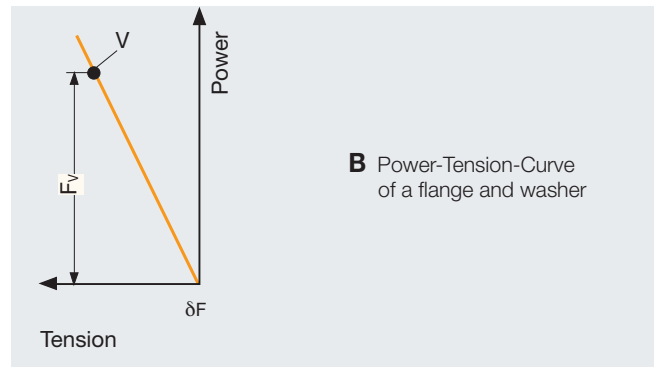
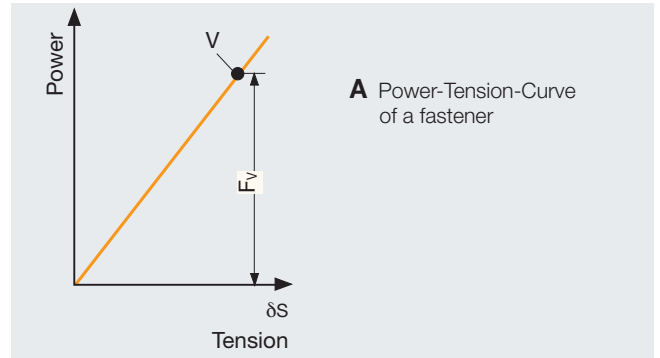

Basics of the Screwdriving Technology

Assembly tightening torque and assembly preload force

$$M_A = F_M \cdot \left[0.16 \cdot P + \mu_G \cdot 0.58 \cdot d_2 + \frac{D_{km}}{2} \cdot \mu_K \right]$$

M_A = Assembly tightening torque

F_M = Assembly preload force

P = Thread pitch

μ_G = Thread friction value

μ_K = Head friction value

d_2 = Standard thread diameter

D_{km} = Effective diameter for the friction torque in the screw head connecting with the surface

Headless screws with standard metric thread									
Thread	Friction coefficient μ total	Max. preload force $F_{M \max}$ [N]				Max. tightening torque $M_{A \max}$ [Ncm]			
		Strength class in accordance with ISO 898/1				Strength class in accordance with ISO 898/1			
		6.8	8.8	10.9	12.9	6.8	8.8	10.9	12.9
M1.6	0.10	470	627	882	1058	11.3	15.1	21.2	25.5
	0.12	455	607	854	1025	12.6	16.9	23.7	28.5
	0.14	441	588	826	992	13.9	18.5	26.0	31.2
M2	0.10	779	1039	1461	1754	23.8	31.7	44.5	53.5
	0.12	756	1008	1417	1701	26.7	35.6	50.0	60.0
	0.14	732	976	1373	1647	29.4	39.2	55.0	66.0
M2.5	0.10	1294	1725	2426	2911	49.0	65.0	91.0	109.0
	0.12	1257	1676	2356	2828	55.0	73.0	103.0	123.0
	0.14	1219	1625	2285	2742	60.0	81.0	113.0	136.0
M3	0.10	1936	2582	3631	4357	84.0	112.0	158.0	190.0
	0.12	1883	2510	3530	4236	95.0	127.0	179.0	214.0
	0.14	1827	2436	3426	4111	105.0	141.0	198.0	237.0
		Max. preload force $F_{M \max}$ [kN]				Max. tightening torque $M_{A \max}$ [Nm]			
M4	0.10	3.4	4.5	6.7	7.8	1.9	2.6	3.9	4.5
	0.12	3.3	4.4	6.5	7.6	2.1	3.0	4.6	5.1
	0.14	3.2	4.3	6.3	7.4	2.4	3.3	4.8	5.6
M5	0.10	5.5	7.4	10.8	12.7	3.8	5.2	7.6	8.9
	0.12	5.3	7.2	10.6	12.4	4.3	5.9	8.6	10.0
	0.14	5.2	7.0	10.3	12.0	4.8	6.5	9.5	11.2
M6	0.10	7.7	10.4	15.3	17.9	6.6	9.0	13.2	15.4
	0.12	7.5	10.2	14.9	17.5	7.5	10.1	14.9	17.4
	0.14	7.3	9.9	14.5	17.0	8.3	11.3	16.5	19.3
M8	0.10	14.2	19.1	28.0	32.8	16.1	21.6	31.8	37.2
	0.12	13.8	18.6	27.3	32.0	18.2	24.6	36.1	42.2
	0.14	13.4	18.1	26.6	31.1	20.1	27.3	40.1	46.9
M10	0.10	22.5	30.3	44.5	52.1	32.2	43.0	63.0	73.0
	0.12	21.9	29.6	43.4	50.8	36.5	48.0	71.0	83.0
	0.14	21.3	28.8	42.2	49.4	40.6	54.0	79.0	93.0
M12	0.10	32.8	44.1	64.8	75.9	55.0	73.0	108.0	126.0
	0.12	32.0	43.0	63.2	74.0	62.0	84.0	123.0	144.0
	0.14	31.1	41.9	61.5	72.0	69.0	93.0	137.0	160.0
M14	0.10	45.1	60.6	88.9	104.1	88.0	117.0	172.0	201.0
	0.12	43.9	59.1	86.7	101.5	100.0	133.0	195.0	229.0
	0.14	42.7	57.5	84.4	98.8	111.0	148.0	218.0	255.0
M16	0.10	61.8	82.9	121.7	142.4	134.0	180.0	264.0	309.0
	0.12	60.2	80.9	118.8	139.0	153.0	206.0	302.0	354.0
	0.14	58.6	78.8	115.7	135.4	171.0	230.0	338.0	395.0
M18	0.10	75.3	104.0	149.0	174.0	187.0	259.0	369.0	432.0
	0.12	73.4	102.0	145.0	170.0	212.0	295.0	421.0	492.0
	0.14	71.3	99.0	141.0	165.0	236.0	329.0	469.0	549.0
M20	0.10	96.5	134.0	190.0	223.0	262.0	363.0	517.0	605.0
	0.12	94.1	130.0	186.0	217.0	300.0	415.0	592.0	692.0
	0.14	91.6	127.0	181.0	212.0	334.0	464.0	661.0	773.0
M22	0.10	120.3	166.0	237.0	277.0	353.0	495.0	704.0	824.0
	0.12	117.4	162.0	231.0	271.0	403.0	567.0	807.0	945.0
	0.14	114.3	158.0	225.0	264.0	451.0	634.0	904.0	1057.0
M24	0.10	139.0	192.0	274.0	320.0	451.0	625.0	890.0	1041.0
	0.12	135.5	188.0	267.0	313.0	515.0	714.0	1017.0	1190.0
	0.14	131.8	183.0	260.0	305.0	574.0	798.0	1136.0	1329.0

Basics of the Screwdriving Technology

Headless screws with metric fine thread							
Thread	Friction coefficient μ_{total}	Max. preload force $F_{M\ max}$ [kN]			Max. tightening torque $M_{A\ max}$ [Nm]		
		8.8	10.9	12.9	8.8	10.9	12.9
M8x1	0.10	20.7	30.4	35.6	22.8	33.5	39.2
	0.14	19.7	28.9	33.9	39.2	44.9	50.1
M10x1.25	0.10	32.4	47.5	55.6	44.0	65.0	76.0
	0.14	30.8	45.2	52.9	57.0	83.0	98.0
M12x1.25	0.10	49.1	72.1	84.4	79.0	116.0	135.0
	0.14	46.8	68.7	80.4	101.0	149.0	174.0
M12x1.5	0.10	46.6	68.5	80.1	76.0	112.0	131.0
	0.14	44.3	65.1	76.2	97.0	143.0	167.0
M14x1.5	0.10	66.4	97.5	114.1	124.0	182.0	213.0
	0.14	63.2	92.9	108.7	159.0	234.0	274.0
M16x1.5	0.10	89.6	131.6	154.0	189.0	278.0	325.0
	0.14	85.5	125.5	146.9	244.0	359.0	420.0

Tension screws with standard metric thread							
Thread	Friction coefficient μ_{total}	Max. preload force $F_{M\ max}$ [kN]			Max. tightening torque $M_{A\ max}$ [Nm]		
		8.8	10.9	12.9	8.8	10.9	12.9
M6	0.10	7.3	10.7	12.5	6.2	9.1	10.7
	0.14	6.8	9.9	11.6	7.7	11.3	13.2
M7	0.10	10.8	15.9	18.6	10.5	15.5	18.1
	0.14	10.1	14.8	17.4	13.2	19.3	22.6
M8	0.10	13.4	19.7	23.1	15.2	22.3	26.1
	0.14	12.5	18.4	21.5	18.9	27.8	32.5
M10	0.10	21.5	31.5	36.9	30.0	44.0	52.0
	0.14	20.1	29.5	34.5	38.0	55.0	65.0
M12	0.10	31.4	46.1	53.9	52.0	77.0	90.0
	0.14	29.4	43.1	50.5	65.0	96.0	112.0
M14	0.10	43.2	63.4	74.2	83.0	122.0	143.0
	0.14	40.4	59.4	69.5	104.0	153.0	179.0
M16	0.10	60.1	88.3	103.4	131.0	192.0	225.0
	0.14	56.5	82.9	97.0	165.0	242.0	283.0
M18	0.10	75.0	106.0	124.0	186.0	264.0	309.0
	0.14	70.0	100.0	117.0	232.0	331.0	387.0
M20	0.10	97.0	138.0	162.0	264.0	376.0	440.0
	0.14	91.0	130.0	152.0	332.0	473.0	554.0
M22	0.10	122.0	174.0	203.0	363.0	517.0	605.0
	0.14	115.0	163.0	191.0	460.0	655.0	766.0
M24	0.10	140.0	199.0	233.0	454.0	646.0	756.0
	0.14	131.0	187.0	218.0	572.0	814.0	953.0

Tension screws with metric fine thread							
Thread	Friction coefficient μ_{total}	Max. preload force $F_{M\ max}$ [kN]			Max. tightening torque $M_{A\ max}$ [Nm]		
		8.8	10.9	12.9	8.8	10.9	12.9
M8x1	0.10	15.0	22.1	25.8	16.6	24.3	28.5
	0.14	14.1	20.7	24.3	20.9	30.7	35.9
M10x1.25	0.10	23.5	34.5	40.4	32.0	47.0	55.0
	0.14	22.1	32.4	37.9	41.0	60.0	70.0
M12x1.25	0.10	36.4	53.4	62.5	58.0	86.0	100.0
	0.14	34.2	50.3	58.8	74.0	109.0	127.0
M12x1.5	0.10	33.8	49.7	58.1	55.0	81.0	95.0
	0.14	31.8	46.6	54.6	70.0	102.0	120.0
M14x1.5	0.10	49.0	72.0	84.2	91.0	134.0	157.0
	0.14	46.1	67.7	79.3	116.0	171.0	200.0
M16x1.5	0.10	66.9	98.3	115.0	141.0	207.0	243.0
	0.14	63.1	92.7	108.5	181.0	265.0	310.0

Tightening Process

Torque-Controlled Tightening

Within screwdriving technology, torque is still used most frequently as the control parameter.

The preload force resulting from the tightening torque is significantly influenced by the fluctuating coefficient of friction as well as the screwdriving device's torque spread. In particular one must differentiate between head friction and thread friction. The sum of these fluctuating frictional conditions results in fluctuations of the preload force of up to 50 % or more, despite high torque repeatability.

This means that the screw connection always needs to be so over-dimensioned that it is not overtightened if a deviation in the upper range occurs and that the required preload force is still applied in the case of a lower deviation. Despite these drawbacks, torque-controlled tightening has emerged as the most popular tightening procedure. This is because technical realisation is relatively simple.

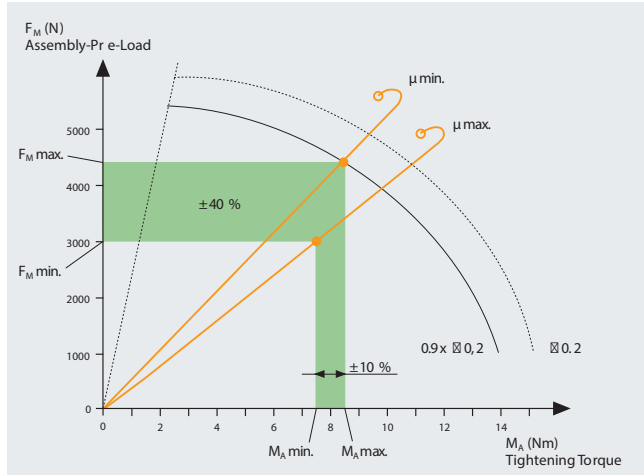

Friction Influence during torque-controlled tightening

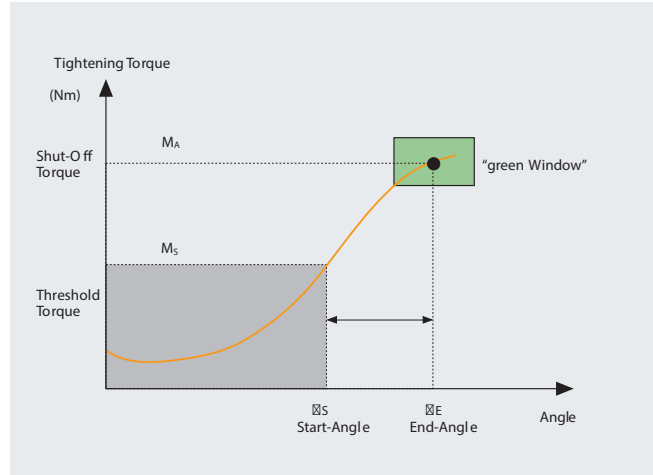

Additional angle monitoring at torque-controlled tightening

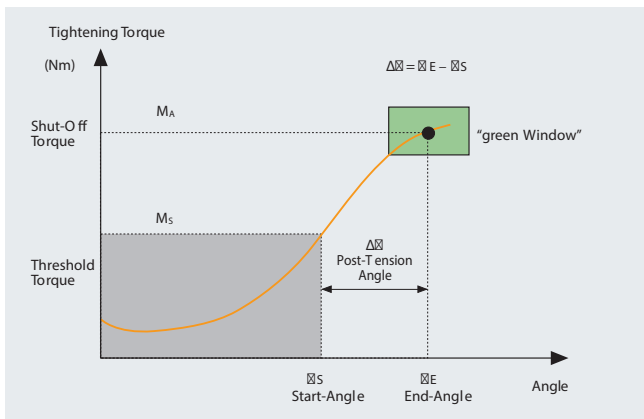

Angle-controlled tightening

Angle-Controlled Tightening

During a so-called angle procedure, both the torque and angle of the screw connection are used as control parameters. In this case, it is the angle and not the torque which is used as the control parameter for the final tightening stage. This means that the screw is tightened to a specific threshold torque and tightening continues from there at a predetermined post-tension angle. The torque can be monitored as an additional control parameter.

Angle-controlled shut-off can be used in both the elastic and plastic range of the screw. The angle-controlled tightening is independent of the head friction. The total preload force is therefore lower than with the torque-controlled screwdriving procedure.

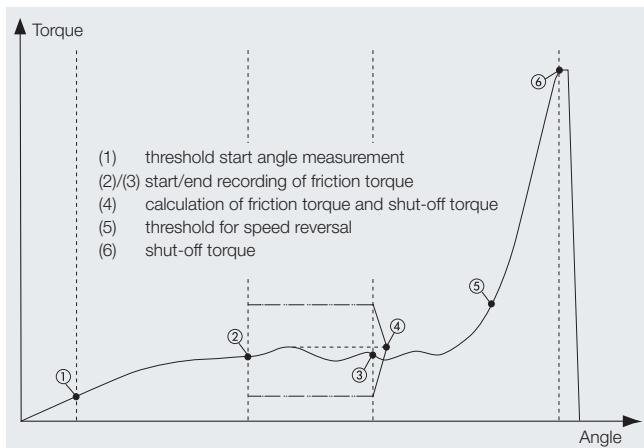

Friction Measurement and Friction Dependent Torque Screw Assembly

The friction value procedure is frequently used for testing processes. Here, the results of the friction value measurement are used to evaluate the quality of gears, threads or to determine minimum friction e.g. with self-locking threaded pins. Screw assembly to difference torque or angle independent from the friction torque is still an option.

Limit-Value Controlled Tightening

In order to optimally utilise the material properties of the screw by reaching the plastic deformation range, a limit-value controlled tightening procedure can be used. Here as well, torque and angle are recorded as control parameters. The declining pitch in the stress-strain diagram when reaching the limit value is used as the shut-off criterion.

Tightening Process

Looking at the stress-strain diagram you can see that the increase is linear at first and levels out upon reaching the limit value. The axial force acts in proportion to the torque – the strain is proportional to the angle. Mathematically, the increase of a curve is defined as the reduction of the function. If the reduction of the torque falls to approximately 50 % of the benchmark, the limit value is reached and the tightening process is ended. It is possible to overlay this process with angle and torque limits for additional safety.

This procedure reduces the drawbacks of fluctuating friction values or the restrictions of a specifically selected screw. The screws used can be dimensionally smaller in size due to the increased safety when reaching the necessary assembly preload force. The limit-value control may only be used on highly accurate steel connections as the represented stress-strain diagram is only valid in these cases. This procedure places high demands on the measurement and regulation technology of the screwdriving system if small or miniaturised screws are used.

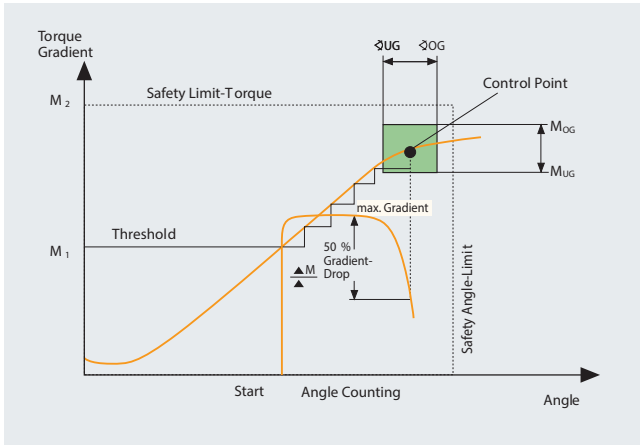

Limit-value controlled tightening

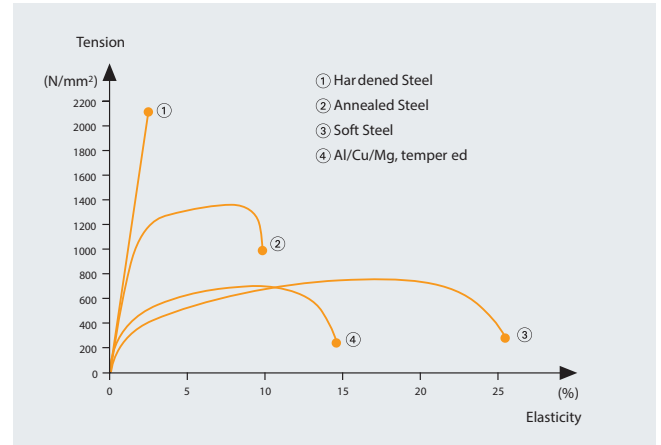

Hook'sches Tension-/Elasticity Diagram

Adaptive tightening procedure DEPRAG Clamp Force Control (CFC)

This patented, reliable and adaptive screwdriving procedure provides excellent constancy in the preload force even with fluctuating torque. The complete screw assembly consists of the screwdriving template seating point detection and a screw assembly to difference torque or angle. The main element is the seating point detection. On the basis of a torque procedure a mathematical evaluation function is continuously formed. If the trend line reached exceeds a specifically defined limit value, the seating point is considered detected and the torque and angle values at the time of the seating point are saved.

The evaluation procedure combines two essential advantages. It is robust in relation to coincidental fluctuations and increases during the torque procedure which do not arise from the actual seating point. Furthermore, the algorithm is universally valid so the user does not need to set any parameters specific to the evaluation. The parameters listed in the table must be set. Torque upper limit is the abort criterion for the screwdriving step. The OK window for the seating point detection can optionally be monitored by seating point torque lower/upper limit and angle lower/upper level. Either the torque or angle values at the seating point or at the end of the program step can be stored as the end values.

The end values of the screwdriving template seating point detection portray the reference for the follow-on program step. Instead of screw assembly to difference torque the other option is screw assembly to angle.

The screwdriving procedure is used for applications where varying limiting conditions are present which can cause widely ranging torques. Using a torque controlled tightening procedure, even if there is the highest shut-off accuracy, can lead to large fluctuations in the resulting preload force. The new adaptive screwdriving procedure DEPRAG Clamp Force Control ensures uniform output for the follow-on end tightening due to the reliable detection of the seating point. Consequently, there is a better constancy in the preload force. Typical application examples are direct screw assemblies in plastic or metal.

The procedure DEPRAG Clamp Force Control does not replace the friction value measurement or the friction dependent screw assembly. The screwdriving template friction value measurement can be used if compliance with the pre-set frictional value needs to be monitored.

The friction dependent torque assembly also enables a good constancy of the preload force for constant frictional torque procedures where the screw position varies. A screw joint analysis is recommended to determine the most suitable screwdriving procedure.

Parameter	Function
Monitoring time	Monitoring time for screwdriving step
Speed	Speed for screwdriving step
Seating point torque lower/upper limit	Monitoring criterion for seating point detection
Torque upper limit	Abort criterion for screwdriving step
Angle lower limit	Monitoring criterion in relation to seating point, min. 720°
Angle upper limit	Monitoring criterion in relation to seating point
End value generation	Values for seating point / end program step, basis for sequential step

Tab.: Parameters for screwdriving template seating point detection

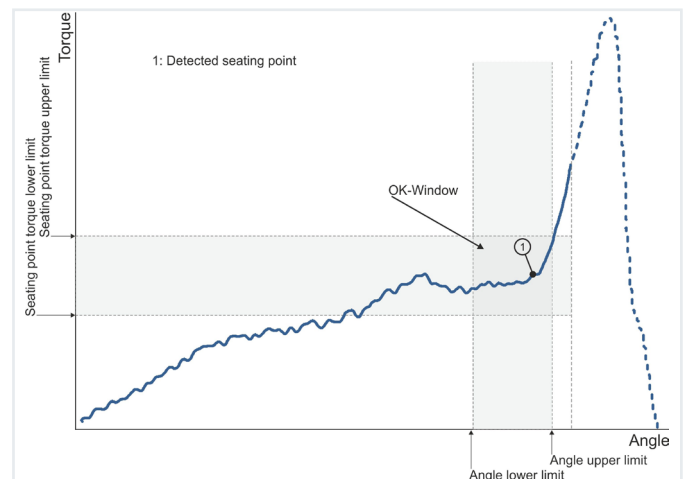

Tightening Process

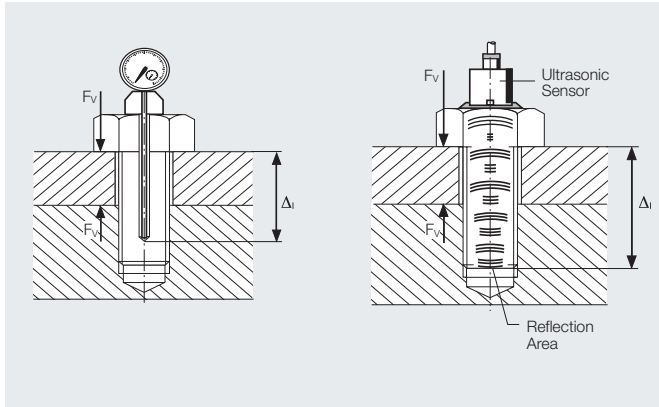

Length measurement

Length Measurement

The mathematical context between the tension of the screw and the created preload is much more accurate than the connection between the torque and the preload. A direct tension measurement leads therefore to a much more accurate preload value. This can be accomplished for example by the mechanical measurement of a bore in the screw, which must be deeper than the clamping length of the used screw. However, this method is only suitable for special cases using large screws and it practically does not find many applications.

Ultrasonic Linear Measurement

Another method is to acquire a screw's tension using the time-measurement of an ultrasonic wave. To this an ultrasound-impulse is brought into the screw-head.

The impulse multiplies throughout the screw, reflects on the shaft-end of the limit-surface steel/air and returns back to the screw-head.

The time-difference between the 1st and 2nd impulse echo is used to measure the screw length. This measurement can be high-frequency, so that a high resolution can be reached with several thousand measurements per second.

Different tension conditions of the screw-material, as well as the temperature of the screw must still be compensated. This procedure has already been developed for series production of extreme sensitive safety screw-connections in the automotive industry. Still, even with this procedure, it is necessary to additionally monitor torque and angle.

This procedure requires special screws with an integrated sensor. Consequently, with each processed screw, an expensive sensor-element remains inside the assembled part.

Special Cases

Almost all previously described proceedings only apply to metric screw-connection into steel. In the practice, there is a multitude of screw-connections, especially sheet metal assemblies, self-drilling or self-forming screws as well as screw-connections with metallic screws in thermoplastic or thermo-setting plastics. It should be pointed out at this time that special tightening requirements apply for those assembly cases.

Basically, there is also a connection between obtained torque, friction values and the generated assembly preload. However, because of very different product material-characteristics, the context cannot be taken care of by the screw material-characteristics alone. With self-drilling or self-forming screws, additional error variables occur, requiring a so-called insertion torque.

Here, the constructively correct design of the screw-connection is very important. With the tightening of thread-forming and thread-cutting screws, high driving torque-values are necessary.

These driving torque-values occur close to the seating torque-value. Only when the screw-connection is designed so that after the forming of the thread and prior to seating of the screw head, a free run-through is guaranteed, then the displayed connections of the torque-controlled tightening diagram apply.

It is however important that the torque shut-off is bridged during the driving of the screw, so that a premature shut-off of the screwdriver is avoided. Such a specialized case can be solved by our extraordinary SENSOMAT screwdriver, which is available as a handheld- and stationary tool.

In other cases, where for example a thread is molded into a blind hole, it is necessary to not only achieve a final-torque but to also consider friction values and especially thread-forming values. Because of large fluctuations of the driving torque, the remaining inaccuracies of the obtained preload are in any case far higher than in the previously described standard cases. Especially with direct-drive into thermo-setting plastics, the right screwdriver speed is of great importance.

Selection of a Suitable Screwdriving System / Application Advice

DEPRAG offers a comprehensive range of screwdriving tools for the most varied of applications. Tools for the assembly of sophisticated products with high requirements in process reliability are dealt with differently to e.g. an impact wrench which can be used in a broad assembly field.

The selection of the right screwdriving tool has to follow varied criteria for example:

- manual or stationary use
- shape: straight, pistol grip or angle design
- shut-off principle: with electronic tools, with mechanical shut-off clutch, with direct drive
- drive medium: pneumatic or electric
- requirements for process reliability, flexibility, documentation etc.

For a better understanding of the features of the DEPRAG screwdriving system some technical terms should be explained:

EC-Servo Screwdriver (e.g. MINIMAT-EC-Servo Screwdriver):

Electronically controlled screwdriver with brushless direct-current motor and integrated sensor technology for torque and angle; cabled power supply

EC Screwdriver (e.g. MINIMAT-EC Screwdriver):

Electronically controlled screwdriver with brushless direct-current motor, torque measurement based on a highly accurate measurement of the motor current; cabled power supply

EC Cordless Screwdriver (e.g. MINIMAT-EC Cordless Screwdriver):

Electronically controlled screwdriver with brushless direct-current motor, torque measurement based on a highly accurate measurement of the motor current; battery power supply

Electric Screwdriver with Mechanical Shut-off Clutch:

Drive with brushless direct-current motor, shut-off via mechanical shut-off clutch

Cordless Screwdriver with Mechanical Shut-off Clutch:

Drive with brushless direct-current motor, shut-off via mechanical shut-off clutch; battery power supply

Pneumatic Screwdriver (e.g. MINIMAT Pneumatic Screwdriver):

Shut-off via highly accurate mechanical shut-off clutch

Pneumatic Screwdriver (e.g. SENSOMAT Pneumatic Screwdriver):

Shut-off via highly accurate mechanical shut-off clutch; clutch also has an additional mechanical lock; use for e.g. thread forming screws

Further detailed information can be found in our "Guideline for the Selection of Screwdriving Technology" on www.DEPRAG.com.

Customisation of screwdriving technology to meet the needs of individual customer applications can only be carried out after specific analysis of the components to be assembled. Choosing DEPRAG means you get decades of experience in screwdriving technology, professionally equipped analysis and testing laboratories as well as a DAkkS accredited calibration laboratory and a large team of application specialists on hand.

Process Reliability

1. Designing the screw-connection and selecting a tool

A screwdriving task will only be achieved with maximum processual safety, if it is done using highly accurate screwdriving equipment. The selection of the right screwdriver for the correct application plays a leading role in guaranteeing the processing safety of the assembly task; naturally the training of the personnel and the use of quality hardware is of importance as well. Crucial factors of a screw joint are the selected fastener(s) and the used materials. Important note: the screwdriver must be optimally adapted to fit the application. In our screwjoint analysis, we check the correlation, for example through detecting friction losses and by researching any occurring joint settlement. Also, when application-specific abnormalities are present, a screwjoint-analysis discovers any assembly problem and determines the process-reliable parameters and sequences. After completion of our extensive testing and evaluating the analysis, a recommendation is made to the manufacturer in regards to which is the best-suitable screwdriving parameter and the correct screwdriving equipment that needs to be used for the application.

2. Qualifying Screwdrivers

To qualify screwdrivers, we can perform a Machine Capability Study (MFU) or English Cmk. According to the hazard condition, the testing and monitoring of the screwdriving process is an important criteria.

For the automotive sector, the VDI guideline 2862 with 2 safety categories and their safeguarding measures are clearly stated.

3. Testing and monitoring the assembly process

For the adherence of the process reliability, the screwdrivers have to be tested on regular basis or after operating for a predetermined number of cycles. Their functionality has to be tested and verified, prior to them going back out on the line. If a maintenance or repair was performed, then a new Machine Capability Study (Cmk) has to be performed. For the evaluation of the screwdriving process, in regards to capability and stability, a Process Capability Study (Cpk) applies. For such a study, the torque – during the screwdriving process – using an external rotary, non-contact transducer, is acquired and analyzed (Cpk-value). Problems include the often unknown seating conditions of the connection and the assembly related fluctuations in preload force.

4. Seating Processes

Generally all described tightening procedures (pages 5, 6 and 7) only consider the torque applied in the exact moment of tightening or the created preload force.

Process Reliability

However as already shown in the preload diagram – image D (under Basics of Screwdriving Technology page 3) there is a settling of the screw joint which in practically all cases reduces the remaining torque or preload force.

Seating processes appear during screw assembly of soft materials e.g. screw assemblies of plastics or if sealing elements are placed between two part to be screw assembled.

An example: A silicone seal is assembled between the pump housing and cover using four screws. Even if the tightening torque allows for one hundred percent preload force this will gradually be lost as the silicone settles. As a consequence: the pump is not sealed.

This situation often leads to problems in quality monitoring of screw-driving systems. Only in a few cases seating conditions can be exactly calculated in advance. Almost always time consuming experiments on original parts must be carried out. DEPRAG can support you with comprehensive screw joint analysis. The result of this analysis is a statement of the suitable tightening torque and the ideal tightening procedures. Seating conditions are hereby taken into consideration. When working with so-called “soft screw joints” the technician tests the screw first up to the determined tightening torque and then again and again after a certain amount of time. The “additional torque” sheds light on the seating conditions and their influence on the preload force.

For many screw joints it has been shown that the largest part of the seating process already takes place in the very first milliseconds after tightening.

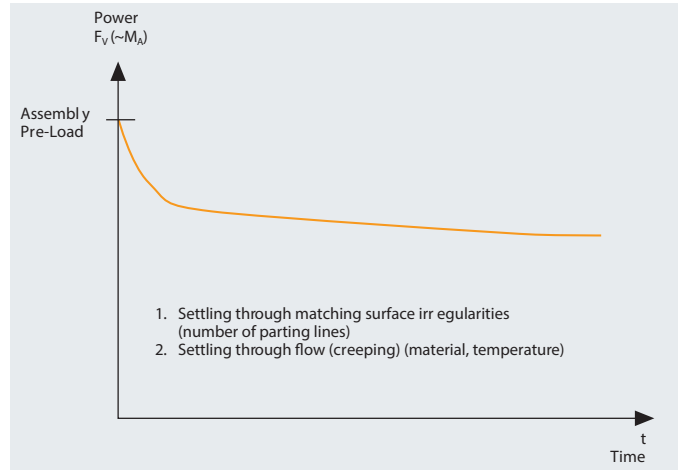

Seating processes

This means that in some problematic cases improvements can be made just by using a slightly lower tool speed as the tightening procedure is thereby protracted and a large part of the seating process will then occur during tightening.

If this measure does not go far enough then there is the option to split the tightening into steps. This can be carried out e.g. with tightening to 80 % of the end torque, a waiting period and finally the end tightening.

There are practically any combinations of pre-tightening, standby time, screw joint loosening and retightening available.

5. Retightening of a Screw Connection

If an exact guarantee in regards to accuracy is required, then it is necessary to clearly define the corresponding measuring procedure. The evaluation of a settling condition can in effect only be accomplished by re-tightening the screw-connection. Also, it is imperative to use exact and identically repeatable measuring methods to obtain accurate results. For example, the time of the re-tightening and the selection of the required measuring technology have to be clearly determined. Principally, the re-tightening process requires exact measurements that can only be performed using a suitable measuring instrument, such as our models ME5500/ME6000 in connection with a torque wrench. Mechanical torque wrenches are inappropriate, because they are much too inaccurate. The entire re-torquing process must be documented. Only after an evaluation of the re-torquing process it will be possible to reconsider the original torque value. Normally, a resting connection results into a higher static friction coefficient, which can be measured using a mechanical torque wrench. Thereafter, the connection goes through so-called Stick-Slip-Effect where the torque is reduced.

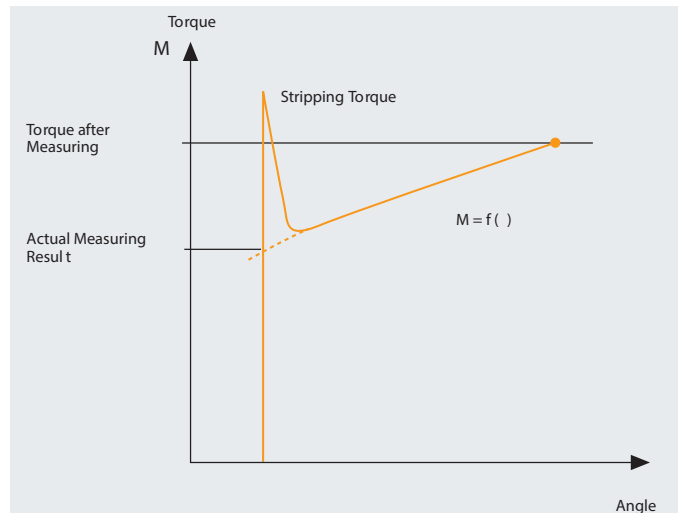

Retightening of a screw connection

Only after another linear increase of the connection it is possible to recapture the original torque.

With all measuring technical problems, this is still a very effective quality control method. It is important, to become familiar with this procedure, since it may also be used for other tasks, such as the fine-adjustment of pulse tools.

Once again: Mechanical torque wrenches can only be used to recognize a primary assessment and they cannot replace an exact measurement.

Statistics

Statistical Basis

To retain an equal and permanent production quality, exact production means as well as suitable control-mechanisms are necessary. Through new and stricter regulations in the product liability area, the requirements in regards to quality documentation will continue to rise. Especially the car industry has taken on a forerunner role in this matter and has enforced its numerous suppliers to take similar measures. This documentation measure applies in particular to our screwdriving technology.

Besides the need to display a selection of suitable measuring units (torque, angle, depth, etc.) it is also necessary to statistically evaluate the assembly results.

There are several mathematical distribution models. The screw-assemblies can be easily displayed using the well-known Gaussian standard distribution, which has the advantage that this method is well known and requires relative simple mathematics.

Average:

The average value of a measurement series can be defined as an arithmetic or geometrical value. In this connection, the arithmetical value \bar{x} is always calculated according to the following formula:

$$\bar{x} = \frac{1}{n} \cdot \sum_{i=1}^n x_i$$

The average value of a measuring series is the value, which in all probability comes closest to the actual value. This statement is only valid if an adequately large number of measuring values have been used. In the practical application, the number of 10 measuring values has shown to be the minimum requirement.

Measurement Row:

The measurement row is a series of measuring values, which are determined using identical conditions. To obtain a statistical statement, a test series of a minimum of 10 values is required; however using 50 values is even better.

Standard Deviation:

The standard deviation of a test series is determined by the average difference of individual measuring values in connection to the calculated average value. The standard deviation s is calculated according to the following formula:

$$s = \sqrt{\frac{\sum_{i=1}^n (x_i - \bar{x})^2}{n - 1}}$$

The value range of the standard deviation is always understood as \pm interval. Usually the precision of a tool is shown with the relative standard deviation. It is also of great importance for the deduction of other statistical dimensions.

Understanding the characteristics of the standard deviation:

If a measuring series acquires solely the random errors, then the distribution of the results fall within the Gaussian standard deviation. According to the distribution curve, the following statement can be made because of the mathematical context:

- 68.26 % of all measurements will be in a range of $\pm 1 s$
- 95.44 % of all measurements will be in a range of $\pm 2 s$
- 99.73 % of all measurements will be in a range of $\pm 3 s$
- 99.99 % of all measurements will be in a range of $\pm 4 s$

All these statements can only indicate a certain probability, never however an absolute.

At this point, the statement of the accuracy of $< \pm 3 \%$ standard deviation is further clarified.

The value of 3 % is calculated as a percentage statement from the standard deviation by referencing the applicable average value. Practical tests have however shown, that in many cases of the DEPRAG screwdrivers, this accuracy value is actually lower than 3 %.

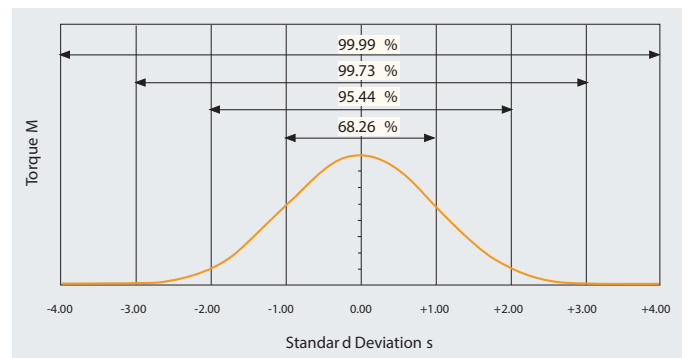

Gaussian standard distribution

Statistics

Capability Study

It is necessary to assign a high importance to the capability study concept, because of the development of the quality-assurance procedures and preventive quality assurances. These statistical methods have a goal, to oversee the manufacturing process during production. An important item of such a study is the determination if the used production machine is even suitable for the production process. Such a study is termed a machine-capability or short-term capability. The used index is designated C_m and C_{mk} , and it confirms whether the required quality characteristics can be kept within pre-determined limits.

For screw assemblies, torque is the crucial unit. In order to give a torque statement, it is necessary to keep the different influencing factors of the assembly process consistent. Consequently a reproducible measuring setup was defined, which has validity for every capability study performed on our screwdrivers. Since only the influence of the machine with its components has to be evaluated in regards to the machine capability study, this study is generally based on 50 measuring values, which have been taken without interruption and under optimal conditions.

The calculation of the machine capability uses the following formula:

$C_m = \frac{OGW - UGW}{6 \cdot s}$	C_{mk}	$\bar{x} - UGW$ and $OGW - \bar{x}$	Within Toleranz	Error Portion
	0.33	1 s	68.26 %	> 30 %
$C_{mk} = \text{MIN} \left(\frac{OGW - \bar{x}}{3 \cdot s} ; \frac{\bar{x} - UGW}{3 \cdot s} \right)$	0.67	2 s	95.44 %	5 %
	1	3 s	99.73 %	0.3 %
$C_m:$ Machine capability index $C_{mk}:$ Machine capability index OGW: Upper limit UGW: Lower limit x: Average of the measuring series s: Standard deviation of the measuring series T: Tolerance	1.33	4 s	99.994 %	60 ppm
	1.63	4.891 s	99.9999 %	1 ppm
	1.67	5 s	99.99994 %	0.6 ppm
	2	6 s	100 %	$2 \cdot 10^{-9}$

Connection of different statistical parameter

The objective is to reach a C_{mk} value of 1.67 or higher, since this value is currently demanded by most of our customers. As can be seen on the C_{mk} calculation formula, a dependence exists between the required limit values (upper and lower limit), the standard deviation s and that machine capability index C_{mk} . The table indicates which of the values result from an ideal symmetrical distribution in connection with the standard distribution and it also shows the theoretical error portion.

How are these values to be interpreted?

The value of C_{mk} is in accordance with above shown table a probability value for the number of incorrect assemblies, which fall outside of the required tolerance. So, if the C_{mk} -value is 1.63 then there is only one incorrect assembly out of a total of one Million assemblies. Additionally, the table shows which driver tolerance is necessary with a maximum $s = 3 \%$ standard deviation, to achieve a C_{mk} -value of 1.67.

A tolerance of 5 s, which means $5 \cdot 3 \% = 15 \%$, is shown. Consequently the standard deviation of the screwdriver is the most important quality characteristics in regards to the machine capability study.

These machine capability studies are documented in a detailed protocol with statements in regards to capability index, histogram and measuring value sequence.

To evaluate and specify the capability of screwdrivers and to offer our screwdrivers with these specifications, we subject new driver models a laboratory condition study in reference to VDI/VDE 2467. This guideline describes in connection with the ISO 5393 a test procedure, which is being used by German car manufacturers for the homologous tests. With this procedure the test conditions are specified within extreme small limits, for example "hard and soft" joints are defined within the torque stage to temperature, nominal entry condition or pre-determined inlet pressure and testing has to be done in regards to these classifications many hundred of times.

Each individual test cycle is documented and at the end all studies are included in the total evaluation. The test-device must have special qualifications. As measuring chain, it may only show a measuring uncertainty according to class 1 of DIN 51309. The measuring instrument capability has to be in accordance with class 0.2 of DIN 51309 of a calibrated measuring chain and it has to be statistically checked once every year.

Statistics

Machine Capability Study

Example of an assembly task: Tightening torque = 5 Nm \pm 10 %
Cmk \geq 1.67

First it is assumed that the average of the measurement series exactly equals the required tightening torque i.e. to determine the max. allowable standard deviation we calculate with C_m = 1.67 instead of C_{mk} = 1.67.

$$\begin{aligned}C_m &= (\text{upper limit value} - \text{lower limit value}) / 6 s \\C_m &= T / 6 s \\s &= T / 6 C_m \\s &= 1.0 \text{ Nm} / 6 * 1.67\end{aligned}$$

$$s = 0.1 \text{ Nm} \text{ or in percent: } s = 2 \%$$

Only tools whose standard deviation is less than or equal to 2 % are suitable for this assembly task.

In practice the average is usually less than the required tightening torque. In the example it should be assumed that a machine capability study of the selected screwdriving tool shows an average of 5.1 Nm with a standard deviation of 0.07 Nm (= 1.4 %). As the average is closer to the upper limit value then the following formula is used:

$$\begin{aligned}C_{mk} &= (\text{upper limit value} - \text{average}) / 3 * s \\C_{mk} &= (5.5 \text{ Nm} - 5.1 \text{ Nm}) / (3 * 0.07 \text{ Nm}) \\C_{mk} &= 1.9\end{aligned}$$

The screwdriving tool is suitable for the assembly task.

If the screwdriving tool showed a standard deviation during the machine capability study of 0.1 Nm (= 2 %) instead of 0.07 Nm then the C_{mk} would be 1.33 and the screwdriving tool would be unsuitable for this assembly task.

Accuracy in the Screwdriving Technology

An intensive discussion is ongoing about a required, necessary and attainable accuracy in the assembly process. We try to specify some concepts.

What does accuracy mean?

First, it is necessary to differentiate between a qualifying accuracy and the accuracy definition according to DIN 55350. In the practical discussion however, accuracy is always meant as a precision concept, especially when assembly is made to torque. Other values, such as angle, distance or time, or even the total process may be termed accuracy.

If concrete values are named, then is always recommended to indicate the relative standard deviation of a measuring series.

For example: Torque shut-off value of 9 Nm with a precision (inaccuracy) from 3 % means, that the tool was subjected to a measuring series with an average of 9 Nm and a standard deviation of ± 3 % in reference to the average of the measuring result.

According to the DIN (ISO) norm, only measuring values may be used that were achieved under perfect test conditions.

Repeatability:

The common description of the concept – repeatability – is defined as precision in accordance to DIN 55350 as “qualitative name for the value of the equal approach of independent evaluation results with multiple applications of a fixed evaluation procedure under pre-determined conditions.”

Basically, the statement of accuracy – according to the above explanation – is always repeatability, since an average value (set-value) is determined using an accuracy (inaccuracy) of 3 % standard deviation from a series of independent measuring values. In the practice, the verified repeatability is again influenced by different parameters.

Therefore, a cyclic testing of the achieved torque value is practical.

Kinetic Energy:

The kinetic energy during an assembly depends primarily on the speed of the used screwdriver.

A slower screwdriver with a mechanical shut-off clutch, causes the movements in the clutch to slow down and therefore it also reduces the dynamic effect. According to our experience, slower screwdrivers have a lower standard deviation than faster screwdrivers.

With electronically controlled screwdriving systems, the influence of the inertia is reduced because the driver slows down when reaching the end of the tightening process.

Measuring Technology:

The measuring technology used for the dynamic process of the screw assembly must be well suited for this task, which means it needs a tough rigidity to vibrations, incorporates filters as well as a suitable algorithm to display the accurate measuring value. Additionally, the drift of the measuring instrument has to be taken into account.

Particular attention has to be given to the sampling rates of the measuring instrument, because highly dynamic screwdriving processes require measuring frequencies of $> 10,000$ Hz.

Many readily available instruments however have sampling rates well below this value!

Because of insufficient sampling rates, the deviation may be 10 % and more.

Absolute Accuracy:

The absolute precision of the screwdriver as well as the measuring instrument is, independent from the repeatability, vitally important. Generally it is only possible to obtain an absolute accuracy for measuring instruments, if they are traceable to national norms. Mainly the screw joint can influence the absolute accuracy of the screwdriver. Because of the above-described effect of the kinetic energy, the same screwdriver may obtain different absolute accuracies.

According to the construction of the clutch, the design of the screwdriving-station (moving masses after the clutch) and the rise of the torque curve, rather large and changing absolute accuracies may occur, because the speed changes at the clutch shut-off. Because of the special construction of our NANOMAT, MICROMAT, and MINIMAT-clutches, the screwdriver itself eliminates these influences, so that there are practically no fluctuations.

Accuracy in the Screwdriving Technology

Because of the need for absolute accuracy, the calibration certificate indicates the measuring uncertainty and points out where the measuring values are located in the tolerance field.

What torque-values are determined?

Of higher importance is the layout of the different measuring transducer and its influence of the absolute values of the screwdriver.

Primarily, it is important to observe which value has to be measured and compared. Integrated screwdriver transducers can always measure only the torque supplied by the screwdriver. If this value is being transmitted as preload or friction, cannot be determined by the sensor.

For clarification, it is necessary to re-check the screw-connection. An exact re-checking is only possible using a measuring electronic, which gives true information about the transition of slip- and slide friction. The breakaway torque will never give a reliable statement in regards to the achieved preload. Also, during re-checking, the actually determined value is changed once again, which worsens the accuracy even more.

With making comparison measurements, there will always be deviations. Settling conditions of the screw-connection are the main cause. Furthermore, there are always different dynamic influences when comparing re-checked values with the original values.

Measuring Principles

For the acquisition of the torque there are several physical principles available: current torsion elements with strain-gauge, eddy current transducers, spring- or hydraulic elements, piezo-electric crystals.

The essential quality feature for the different technologies is the necessary high natural frequency to acquire highly-dynamic signals, a sufficient mechanical stiffness, a high linearity and a general insensitivity to interferences and wear.

According to application, we offer torque transducers with two different physical principles:

DMS (Strain gauge) Transducer
PE (Piezo Electric) Transducer

In connection with a specifically adapted measuring electronic, all our torque-transducers are well suited for applications in the screwdriving technology.

The main advantage of the DMS-transducer is the relative low-cost production, while the known piezo-electric transducers excel through the access of a large measuring range and the extreme robust equipment design.

The torque transducer is available as a stationary measurement platform as well as a mobile torque wrench in straight or angle design. The transducer is designed to connect to the relevant measurement electronic.

Furthermore the torque wrench enables the testing of screwdriver spindles without removing them from the screwdriving station. If required, the torque wrench can also be clamped into a vice using the appropriate clamping surface of the measurement head.

Together with the relevant electronics you can of course also use it for the testing of already fixed joints by retightening (or loosening). This combines the application range of a conventional torque wrench with the precision and possibilities of state-of-the-art electronic measurement technologies.

Measuring Principles

DMS Technology for the Acquisition of the Torque

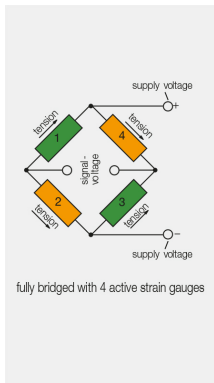

Function principle of the strain gauge transducers

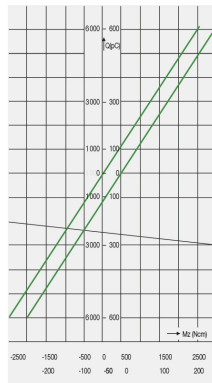
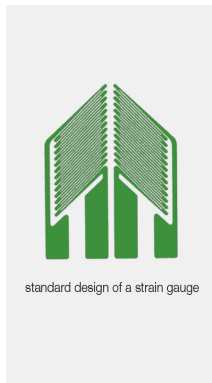

The strain gauge (DMS) technology rests on the principle, that a part is mechanically deformed and this deformation is relayed by a meander-formed wire (= DMS). Through the straining of the wire, a varying electric resistance occurs, which consequently represents the measurement of the materials mechanical deformation.

This procedure is frequently used for tension- and pressure measurements and appears to be simple in its application.

To determine a torque value, the DMS-gauge is generally arranged 45-degrees to the torsion axis and the electrical resistance is obtained by using several gauges.

The usable linear area between the torque and the resistance change

is not as large as with the piezo transducer. They are made to correspond with the respective torque-ranges of our screwdrivers. Because of the rather large spread and many different standard available components, this is a relative low-cost solution.

Piezo Electric Measuring Procedure for the Torque Measurement

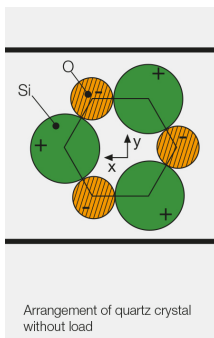

Function principle of the piezoelectric transducers

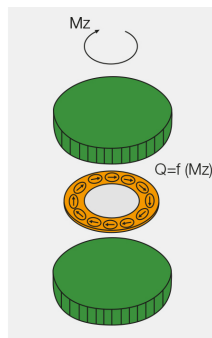
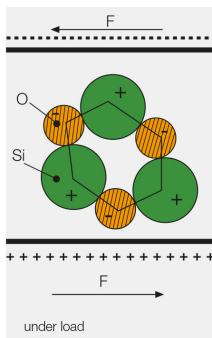

During the piezo electric measuring procedure silicon crystals are elastically deformed, so that an electric load appears on its defined outside surfaces. This load is found to be proportional to the applied force.

Torque is measured using the shown ring-element. The single quartz disks are arranged in such a way, that appearing tangential forces can be measured.

The transducer carries a high preload which allows it to transfer the appearing torque through frictional resistance to the quartz elements. The single elements are arranged parallel, so that the appearing load is proportionally to the transferred torque.

Since the insulation resistance of the charge amplifier and measuring instrument is of a certain size, the occurring load flows only gradually. Piezo electric transducers are therefore only marginally suited for static measurement.

For the use in the screwdriving technology however, the piezo transducer is very well suited because of its

- extreme high dynamic,
- an excellent linearity over a wide measuring range,
- very small size,
- the non-existent wear-parts,
- high rigidity
- and the outstanding general measuring qualities.

Especially very high sampling rates (10 kHz) allow for the torque acquisition of hard screw-joints.

The use of a piezo electric torque measurement cell is particularly attractive for use in stationary measurement platforms due to its wide torque range.

Calibration of Measuring Instruments

Basics and Definitions

One important requirement of the quality assurance system is the traceability of a measuring instrument to national standards. This demand is generally based on ISO 9000 requirements. The traceability is given, if a measuring instrument or measuring system was calibrated in an uninterrupted chain using a reference, which in turn is traceable to national standard.

Definitions:

Verification

Determining, if a demand is fulfilled.

Example: an air-operated shut-off screwdriver is torque tested against a torque transducer. If a deviation is detected, then the screwdriver must be readjusted.

Realignment

Change made to the measuring instrument to eliminate a systematic measuring deviation.

Certification

Testing of a measuring system to agree with the calibration laws as required by the consumer protection agency. This includes checking whether the number of the measuring deviations of each instrument does not exceed the allowable error limits. Thereafter the measuring instrument will be certified by the testing agency or its representative. The calibration law clearly states which measuring instrument needs to be calibrated!

Calibration

Measuring means comparing. A measuring instrument compares something unknown with something known. A measuring instrument needs to be checked, using a calibration process that measures an object with known standard. Any shown deviation for this measurement is called a measurement uncertainty. The smaller the deviation, the more accurate the measuring instrument is measuring.

Standards

A measuring instrument needs to be regularly checked, using a calibration process. Such a calibration process measures an object with known proportions. An object with known proportions is called a "standard". There are standards in different hierarchy steps. These are compared in accordance with a concrete schematic. If the measuring instrument indicates the same value or is within the allowable tolerance range, then the measuring instrument fulfills the specified requirements.

Calibration hierarchy

At the top of the calibration hierarchy stands the Federal Agency of Physical Technology (PTB), which defines the national standards and the national accreditation body (DAkkS) which advises in the accreditation of calibration laboratories.

These accredited calibration laboratories, such as the DEPRAG D-K-18255-01-00, calibrate measurement tools in accordance with fixed calibration procedures and using traceable reference measurement tools.

At the base of the calibration hierarchy are the tools used in production such as screwdriving tools, measurement platforms and measurement devices. These tools are checked at regular intervals using the company's measurement tools.

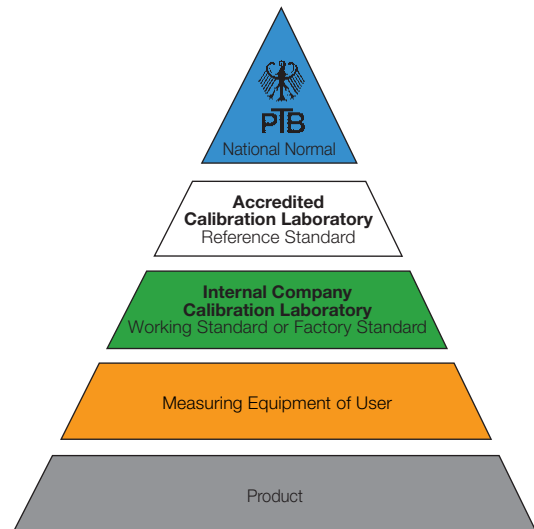

Calibration of Measuring Instruments

Calibration

Comparing a measuring instrument with a reference-measuring-system – under the same conditions – to determine a systematic deviation and to subsequently trace it to national standards. A calibration always acquires the currently IS-condition of an instrument.

Reference Measuring System

The applicable standards must be tested and certified by an accredited entity, such as the DEPRAG calibration laboratory to allow complete traceability.

Measuring Chain

A measuring chain includes all components, from the transducer to the display instrument (transducer, cable, measuring instrument).

Calibration performed by DEPRAG

Basically, all components of the measuring chain have to be independently calibrated. Measuring instruments for the piezo transducer are calibrated using a charge-calibrator and measuring instruments for the strain-gauge transducer are calibrated using a strain-gauge calibrator. Each one of these instruments is connected over a DAkkS-calibrator to the national standards of the Federal Agency of Physical Technology and therefore corresponds to the highest possible quality requirement. The transducers are calibrated in specialized calibration-devices using traceable reference-measuring systems.

Please find more information about the DEPRAG service offers in our brochure services D3330E.

For how long is the calibration valid?

In principle, a calibration is only valid at the time of its performance.

The determination of when to perform a calibration is solely the responsibility of the user. The application, which means the conditions of the workplace, the type of usage of the measuring unit, frequency of use and safety requirements of the product to be assembled, decisively influence the required number of calibration intervals.

If measuring systems are integrated into the moving assembly process, then it will certainly be more meaningful to select shorter calibration intervals compared to measuring systems used in a laboratory environment.

So, calibration cycles of between 3 months and 2 years would be sensible.

We recommend re-calibration of our measurement systems at least once per year.

Standards / Guidelines / Literature

Standards

- **ISO 5393** Rotary tools for threaded fasteners – performance test method
- **DIN 51309** Calibration – torque measuring instruments for static torque
- **DIN 1319** Part 1-3 basics of the measuring technology
- **DIN EN ISO/IEC 17025** General requirement for the competence of test- and calibration laboratories
- **DIN 55350** Concepts of quality assurance and statistics

Guidelines

- **VDI 2230** Systematic calculation of high frequency screw-connections
- **VDI 2862** Use of screwdriving systems in the automotive industry
- **VDI/VDE 2645** Capability study
- **VDI/VDE 2647** Sensors for screwdriving systems
- **VDI/VDE 2648** Instruction for the dynamic testing of tools based on ISO 5393
- **VDI/VDE/DAkkS 2639** Sensors and measuring systems for the angle-measurement
- **VDI/VDE/DAkkS 2639** Parameters for torque-transducers

Literature

- Bauer, C. O.; **Manual of the Fastening Technology** – Carl Hanser Verlag, München, Wien, 1991 ISBN: 3-446-14609-1
- ICS, **Automatic Screwdriver Assembly** – Hans-Herbert Mönnig Verlag Iserlohn, 2003 ISBN: 3-922 885-64-0
- Ruppelt, E., **Manual of the Compressed Air** – Vulkan-Verlag, Essen, 1996 ISBN: 3-8027-2692-8
- ICS **Manual of the Industrial Screw Assembly, 3rd Edition 2007** – Hans-Herbert Mönnig Verlag Iserlohn; ISBN: 9783933519375

DEPRAG

DEPRAG SCHULZ GMBH u. CO. KG

P.O. Box 1352 | D-92203 Amberg

Carl-Schulz-Platz 1 | D-92224 Amberg

Phone: +49 9621 371-0 | Fax: +49 9621 371-120

www.deprag.com | info@deprag.de

CERTIFIED AS PER DIN EN ISO 9001
